

MCG Surge Protection

Installation Instructions For Models PT80 & PT40

Important Warranty Information

MCG surge protectors are designed to work at specific voltages and configurations, for example, at 120/208VAC, Wye. Installation of the surge protector improperly on a power system will automatically void the warranty.

1. Confirm Model with Power Service.

Measure Phase-Neutral, Phase-Phase, and Phase-Ground with voltmeter to confirm application voltage prior to installation.

NOTE: This device features an internal protection that will disconnect the surge protective component at the end of its useful life but will maintain power to the load – now unprotected. If this situation is undesirable for the application, follow the manufacturer's instructions for replacing the device.

WARNING – Risk of Electric Shock:

This unit contains no user serviceable parts.

Voltage Configuration	Power Service	Description	Wiring Diagrams (pg. 2)
120S	120 VAC	1 ph, 2W+G Single phase	1
120T	120/240 VAC	1 ph, 3W+G Split phase	2
120Y	120/208 VAC	3 ph, 4W+G Wye	3
220S	220 VAC	1 ph, 2W+G Single phase	1
220Y	220/380 VAC	3 ph, 4W+G Wye	3
240Y	240/415 VAC	3 ph, 4W+G Wye	3
240DCT	240/120/120 VAC	3 ph, 4W+G High-leg Delta	4
277Y	277/480 VAC	3 ph, 4W+G Wye	3
347Y	347/600 VAC	3 ph, 4W+G Wye	3
240D	240VAC	3ph, 3W+G Delta	5
480D	480VAC	3ph, 3W+G Delta	5
600D	600VAC	3ph, 3W+G Delta	5

2. Disconnect Power before Installation

All wiring to be done in accordance with National Electric Code and local codes by qualified electricians.

3. Mounting

For best performance, mount protector as close to service panel as possible and cut back wires as short as possible. Do not leave service loops. Secure unit to mounting surface. Use proper fasteners as indicated (Fasteners not supplied.)

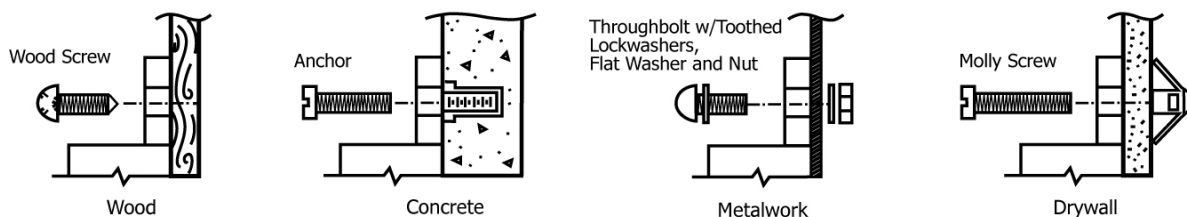

4. Wiring Diagrams

For best performance, conductors should be taped tightly together for the entire run. Cut cable back as short as possible. **Electrician Note:** Use a dedicated 30A, UL489 Listed circuit breaker to connect the protector. Circuit breaker voltage and interrupt rating must be suitable for the service.

Figure 1 (S Models)

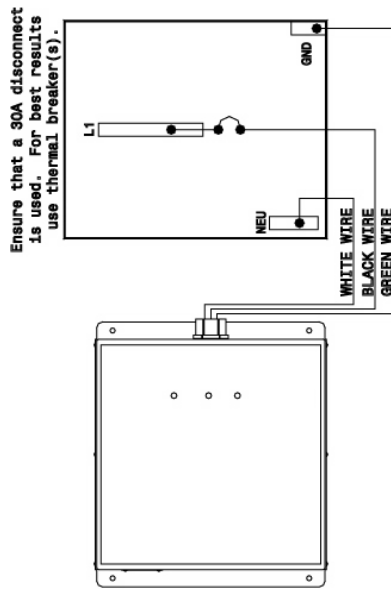

Figure 2 (T Models)

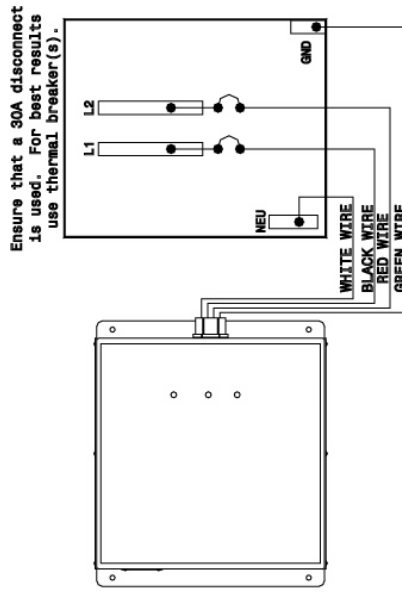

Figure 3 (Wye Models)

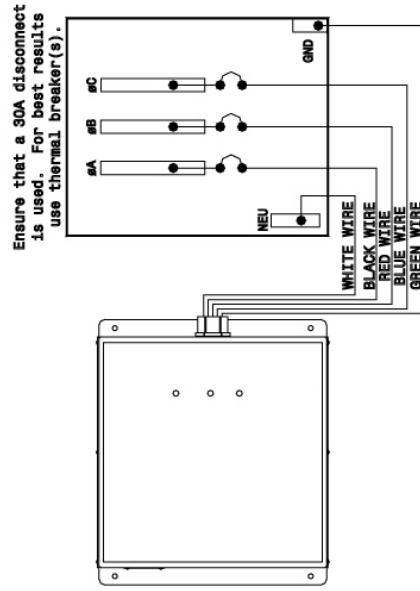

Figure 4 (Hi-Leg Delta)

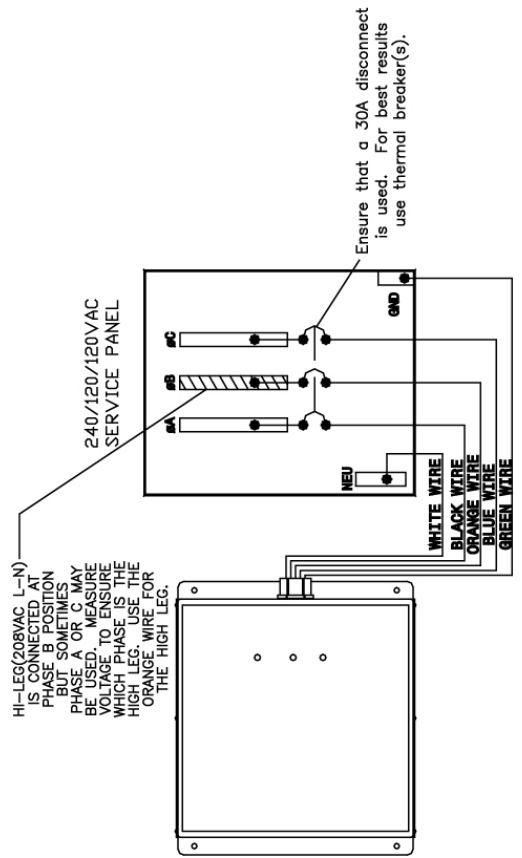
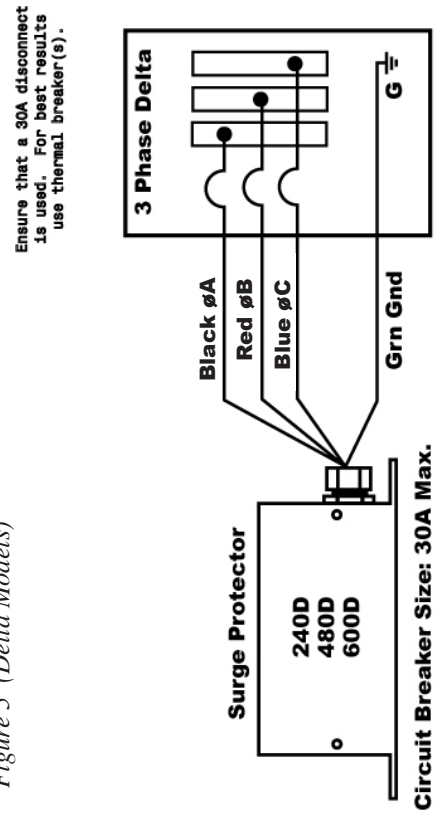

Figure 5 (Delta Models)



5. Powering up the Protector.

Upon power up, the front panel will show the following:

For PT80 and PT40 models without the Event Counter (“-EC”) option:

- a. All Green LEDs are illuminated. Red LED extinguished. Note: If Red LED is on, check power system. Red LED on indicates that there is voltage present between Neutral and Ground. NOTE: The green, front panel LEDs continuously monitor the status of the protection circuits. If a surge component is damaged and/or if a fuse operates, the appropriate LED(s) will extinguish and the relay will change state.
- b. On the side of the unit, a green LED is illuminated (indicating power to the relay coil).

See Figure 6.

If any other condition is observed, remove power and contact MCG at 1-800-851-1508 for assistance.

For PT80 and PT40 with the Event Counter (“-EC”) option:

- a. All Green LEDs are illuminated. Red LED extinguished. Note: If Red LED is on, check power system. Red LED on indicates that there is voltage present between Neutral and Ground. NOTE: The green, front panel LEDs continuously monitor the status of the protection circuits. If a surge component is damaged and/or if a fuse operates, the appropriate LED(s) will extinguish and the relay will change state.
- b. On the side of the unit, a green LED is illuminated (indicating power to the relay coil).
- c. Counter will read “0” or a nonzero value. If desired, see step 6 for counter reset instructions.

See Figure 6 and 6a.

If any other condition is observed, remove power and contact MCG at 1-800-851-1508 for assistance.

Fig. 6: Green LEDs are illuminated. Red LED extinguished. On the side of the unit, a green LED is illuminated (indicating power to the relay coil.)

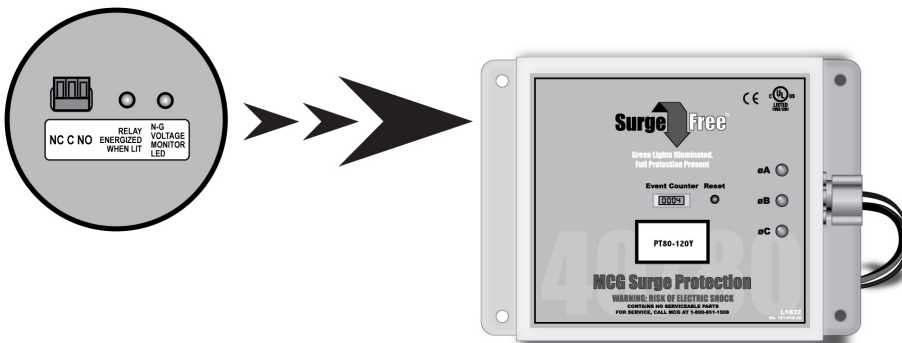

Fig. 6a: Upon startup for the -EC models, counter should read zero. If a non-zero is displayed, the counter can be reset by following Step 6. If the counter is blank, contact MCG Support at 1-800-851-1508.



6. Counter Reset Feature (Models with “-EC” option)

This feature resets the surge counter back to zero. The counter reset feature is generally only exercised at time of installation, where power up may have caused an event. A monthly log is recommended to keep track of transient occurrences. See figure 7.

To reset event counter:

- a. Locate “Counter Reset” location on front panel.
- b. Using a ball point pen, insert into hole and press reset button.
- c. Observe counter indicating “0”.

Fig. 7: Counter Reset on front panel can be reset with the tip of a ball point pen.

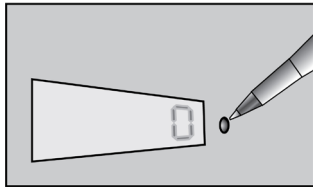

7. Remote Relay Feature

This feature enables you to operate a remote beeper/indicator light for monitoring the surge protector status from a remote location. It can also be connected to a building monitoring system as the relay provides a Normally Closed or a Normally Open contact.

RELAY FUNCTION: The relay is always energized unless power is removed or a reduced protection scenario exists. See figure 8 below.

Fig. 8: Relay Function:

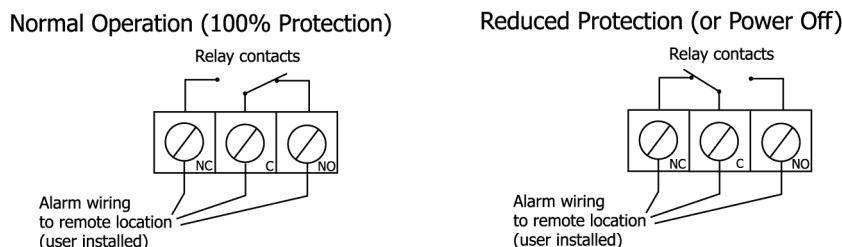

To access remote relay terminal block:

- a. The remote relay terminal block is located on the side of the protector. There are three terminals, each labeled NC (Normally Closed), C (Common), and NO (Normally Open). These are 1 Form C contacts rated at 1A, 30VDC. Maximum switched power: 30W/60VA.
- b. Remove power to protector. Pull out the pluggable terminal block. Connect remote monitoring circuit (user supplied) to the appropriate terminals using a small flathead screwdriver.
- c. Remember that under normal operating conditions (power on and full protection present), the NO – C contacts will be closed (short circuit) and the NC-C contacts will be open.
- d. Plug in terminal block and power up unit.
- e. Observe that external circuit is functioning properly.

Note 1: Class 2 Wiring Only. 16-28 AWG.

Note 2: Recommended screw torque: 2 in-lbs.

8. Troubleshooting and Maintenance

MCG surge protectors do not require any periodic maintenance. However, if any of the front panel green LEDs extinguish, a reduced protection situation exists and the protector should be returned for service. If this occurs, contact MCG sales at 1-800-851-1508.

9. Dimensions for Models PT80 & PT40

Dimensional units are expressed in inches and millimeters.

